VRV SYSTEM Inverter Air Conditioners

MODELS**Ceiling Mounted Cassette type (Round Flow with Sensing Panel)**

FXFQ07TVJU	FXFQ24TVJU
FXFQ09TVJU	FXFQ30TVJU
FXFQ12TVJU	FXFQ36TVJU
FXFQ15TVJU	FXFQ48TVJU
FXFQ18TVJU	

English

Français

Español

Thank you for purchasing this Daikin air conditioner. Carefully read this operation manual before using the air conditioner. It will tell you how to use the unit properly and help you if any trouble occurs. This manual explains about the indoor unit only. Use it along with the operation manual for the outdoor unit. After reading the manual, file it away for future reference.

Nous vous remercions pour votre acquisition de ce système de climatisation Daikin.

Lisez attentivement ce manuel avant d'utiliser le climatiseur. Il vous expliquera comment vous servir correctement de l'appareil et vous guidera en cas de problème. Ce manuel ne décrit que l'unité intérieure. Utilisez-le avec le manuel de l'unité extérieure. Lorsque vous aurez lu le manuel, rangez-le afin de pouvoir vous y référer ultérieurement.

Le agradecemos la compra de este acondicionador de aire Daikin.

Lea cuidadosamente el manual de funcionamiento antes de utilizar el acondicionador de aire. Dicho manual le indicará cómo utilizar adecuadamente la máquina y le ayudará en caso de avería. Este manual describe sólo la unidad interior. Utilice conjuntamente con el manual de instrucciones de la unidad exterior. Después de leer el manual, consérvelo para consultas futuras.

SAFETY CONSIDERATIONS

Read these *Safety Considerations for Operations* carefully before installing air conditioning equipment. After completing the installation, make sure that the unit operates properly during the startup operation. Instruct the customer on how to operate and maintain the unit.

Inform customers that they should store this Operation Manual with the Installation Manual for future reference.

Meanings of **DANGER**, **WARNING**, **CAUTION**, and **NOTE**

Symbols:

 **DANGER**.....Indicates an imminently hazardous situation which, if not avoided, will result in death or serious injury.

 **WARNING**.....Indicates a potentially hazardous situation which, if not avoided, could result in death or serious injury.

 **CAUTION**.....Indicates a potentially hazardous situation which, if not avoided, may result in minor or moderate injury. It may also be used to alert against unsafe practices.

 **NOTE**Indicates situations that may result in equipment or property-damage accidents only.

DANGER

- Do not install the unit in an area where flammable materials are present due to risk of explosion resulting in serious injury or death.
- Any abnormalities in the operation of the air conditioner or heat pump such as smoke or fire could result in severe injury or death. Turn off the power and contact your dealer immediately.
- Refrigerant gas may produce toxic gas if it come in contact with fire, such as from a fan, heater, stove, or cooking device. Exposure to this gas could cause severe injury or death.
- For refrigerant leakage, consult your dealer. Refrigerant gas is heavier than air and replaces oxygen. A massive leak could lead to oxygen depletion, especially in basements, and an asphyxiation hazard could occur leading to serious injury or death.
- If equipment utilizing a burner is used in the same room as the air conditioner or heat pump, there is the danger of oxygen deficiency which could lead to an asphyxiation hazard resulting in serious injury or death. Be sure to ventilate the room sufficiently to avoid this hazard.
- Safely dispose of the packing materials. Packing materials, such as nails and other metal or wooden parts, may cause stabs or other injuries.
- Tear apart and throw away plastic packaging bags so that children can not play with them. Children playing with plastic bags face the danger of death by suffocation.

WARNING

- Contact your dealer for repair and maintenance. Improper repair and maintenance may result in water-leakage, electric shock, and fire. Only use accessories made by Daikin that are specifically designed for use with the equipment and have them installed by a professional.
- Contact your dealer to move and reinstall the air conditioner or heat pump. Incomplete installation may result in water leakage, electric shock, and fire.
- Never let the indoor unit or the remote controller get wet. Water can cause an electric shock or a fire.
- Never use flammable spray such as hair spray, lacquer, or paint near the unit. Flammable spray may cause a fire.
- When a fuse blows out, never replace it with one of incorrect ampere ratings or different wires. Always replace any blown fuse with a fuse of the same specification.
- Never remove the fan guard of the unit. A fan rotating at high speed without the fan guard is very dangerous.
- Never inspect or service the unit by yourself. Contact a qualified service person to perform this work.
- Turn off all electrical power before doing any maintenance to avoid the risk of serious electric shock; never sprinkle or spill water or liquids on the unit. Do not touch the switch with wet fingers. Touching a switch with wet fingers can cause electric shock.
- Do not allow children to play on or around the unit to prevent injury.
- The heat exchanger fins are sharp enough to cut. To avoid injury wear gloves or cover the fins while working around them.
- Do not put a finger or other objects into the air inlet or air outlet. The fan is rotating at high speed and may cause injury.
- Check the unit foundation for damage on a continuous basis, especially if it has been in use for a long time. If left in a damaged condition the unit may fall and cause injury.
- Placing a flower vase or other containers with water or other liquids on the unit could cause a shock or fire if a spill occurs.
- Do not touch the air outlet or horizontal blades while the swing flap is in operation because fingers could get caught and injured.
- Never touch the internal parts of the controller. Do not remove the front panel because some parts inside are dangerous to touch. To check and adjust internal parts, contact your dealer.
- Be sure to ground the unit. Do not ground the unit to a utility pipe, arrester, or telephone ground. Incomplete grounding may cause electrical shock, or fire. A high surge current from lightning or other sources may cause damage to the air conditioner or heat pump.
- This equipment can be installed with a Ground-Fault Circuit Breaker (GFCI). Although this is a recognized measure for additional protection, with the earthing system in North America, a dedicated GFCI is not necessary.



CAUTION

- Do not use the air conditioner or heat pump for any other purposes other than comfort cooling or heating. Do not use the unit for cooling precision instruments, food, plants, animals or works of art.
- Do not place items under the indoor unit as they may be damaged by condensates that may form if the humidity is above 80% or if the drain outlet gets blocked.
- Before cleaning, stop the operation of the unit by turning the power off or by pulling the supply cord out from its receptacle. Otherwise, an electric shock and injury may result.
- Do not wash the air conditioner or heat pump with excessive water. An electric shock or fire may result.
- Avoid placing the controller in a spot splashed with water. Water entering the controller may cause an electric shock or damage the internal electronic parts.
- Do not operate the air conditioner or heat pump when using a room fumigation type of insecticide. Failure to observe this could cause the chemicals to be deposited in the unit and can endanger the health of those who are hypersensitive to chemicals.
- Do not turn off the power immediately after stopping operation. Always wait for at least five minutes before turning off the power. Otherwise, water leakage may occur.
- The appliance is not intended for use by young children or infirm persons without supervision.
- The remote controller should be kept away from children so they cannot play with it.
- Consult with the installation contractor for cleaning.
- Incorrect cleaning of the inside of the air conditioner or heat pump could make the plastics parts break and cause water leakage or electric shock.
- Do not touch the air inlet or aluminum fin of the air conditioner or heat pump as they can cut and cause injury.
- Do not place objects in direct proximity of the outdoor unit. Do not let leaves and other debris accumulate around the unit. Leaves are a hotbed for small animals which can enter the unit. Once inside the unit, animals can cause the unit to malfunction, and cause smoke or fire when they make contact with electrical parts.



NOTE

- Never press the button of the remote controller with a hard, pointed object. The remote controller may be damaged.
- Never pull or twist the electric wire of the remote controller. It may cause the unit to malfunction.
- Do not place appliances that produce open flames in places that are exposed to the airflow of the unit or under the indoor unit. It may cause incomplete combustion or deformation of the unit due to the heat.
- Do not expose the controller to direct sunlight. The LCD display can become discolored and may fail to display the data.
- Do not wipe the controller operation panel with benzene, thinner, chemical dust cloth, etc. The panel may get discolored or the coating can peel off. If it is heavily dirty, soak a cloth in water-diluted neutral detergent, squeeze it well and wipe the panel clean. Then wipe it with another dry cloth.

- Dismantling of the unit, disposal of the refrigerant, oil, and additional parts, should be done in accordance with the relevant local, state, and national regulations.
- Operate the air conditioner or heat pump in a sufficiently ventilated area and not surrounded by obstacles. Do not use the air conditioner or heat pump in the following places.
 - a. Places with a mist of mineral oil, such as cutting oil.
 - b. Locations such as coastal areas where there is a lot of salt in the air.
 - c. Locations such as hot springs where there is a lot of sulfur in the air.
 - d. Locations such as factories where the power voltage varies a lot.
 - e. In cars, boats, and other vehicles.
 - f. Locations such as kitchens where oil may splatter or where there is steam in the air.
 - g. Locations where equipment produces electromagnetic waves.
 - h. Places with an acid or alkaline mist.
 - i. Places where fallen leaves can accumulate or where weeds can grow.
- Take snow protection measures. Contact your dealer for the details of snow protection measures, such as the use of a snow protection hood.
- Do not attempt to do electrical work or grounding work unless you are licensed to do so. Consult with your dealer for electrical work and grounding work.
- Pay attention to operating sound. Be sure to use the following places:
 - a. Places that can sufficiently withstand the weight of the air conditioner or heat pump yet can suppress the operating sound and vibration of the air conditioner or heat pump.
 - b. Places where warm air from the air outlet of the outdoor unit or the operating sound of the outdoor unit does not annoy neighbors.
- Make sure that there are no obstacles close to the outdoor unit. Obstacles close to the outdoor unit may drop the performance of the outdoor unit or increase the operating sound of the outdoor unit.
- Consult your dealer if the air conditioner or heat pump in operation generates unusual noise.
- Make sure that the drainpipe is installed properly to drain water. If no water is discharged from the drainpipe while the air conditioner or heat pump is in the cooling mode, the drainpipe may be clogged with dust or dirt and water leakage from the indoor unit may occur. Stop operating the air conditioner or heat pump and contact your dealer.

CONTENTS

SAFETY CONSIDERATIONS [i] [ii]
 1. NAMES AND FUNCTIONS OF PARTS..... 2
 2. MAINTENANCE (FOR SERVICE PERSONNEL) 2

1. NAMES AND FUNCTIONS OF PARTS

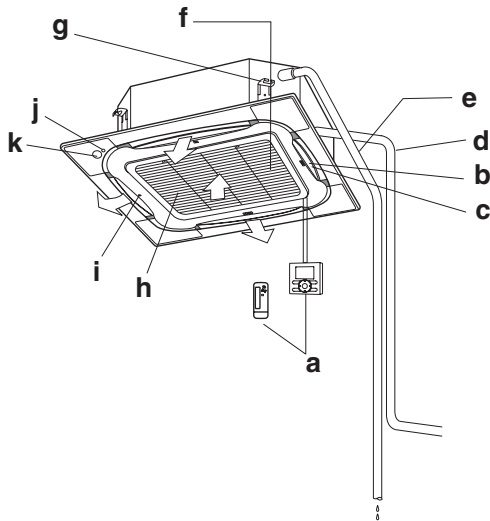

a	Remote controller (optional accessory) The remote controller may not be needed depending on the system configuration.
b	Air outlet
c	Horizontal blade (inside air outlet)
d	Refrigerant piping Transmission wiring Ground wiring * Note that the ground wiring allows electricity flow from the indoor unit to the ground for prevention of electric shocks or fire in case of an emergency. Power supply wiring
e	Drain piping
f	Air filter (inside suction grille) (Refer to 2. MAINTENANCE)
g	Drain device (built-in) It drains moisture in the room removed during the cooling operation.
h	Suction grille (Refer to 2. MAINTENANCE)
i	Air outlet identification mark □, □□, □□□, □□□□ Use this mark as a reference for setting the airflow direction. (only for BRC1E62)
j	Infrared floor sensor It detects the average temperature of the floor surface.

k	Infrared presence sensor It detects whether or not someone is there by means of four sensors corresponding to each air outlet.
----------	---

2. MAINTENANCE (FOR SERVICE PERSONNEL)

ONLY A QUALIFIED SERVICE PERSONNEL IS ALLOWED TO PERFORM MAINTENANCE

⚠ WARNING

- Do not use flammable gas (such as hair sprays and insecticides) near the air conditioner.
- Do not wipe the air conditioner with benzene or thinner. It may cause cracks, electric shocks or a fire.
- Never put your fingers or rods in the air inlet, air outlet, or horizontal blade.
The fan is rotating at high speed, so you would get injured.

⚠ CAUTION

- Do not wash the air conditioner with water. It may cause electric shocks or a fire due to leakage.
- Make sure to turn off the air conditioner while maintenance of the air conditioner and disconnect the power supply breaker.
Unless the power supply is disconnected, it may cause electric shocks and injuries.
- When working at a high place, give caution to your footing.
If the scaffold is unstable, it may cause injuries due to falling and stumbling.

NOTE

- Do not remove the air filter unless for cleaning or it could cause failure.
- Do not attach substance (such as paper towels) other than the specified air filter to the air inlet.
The performance may drop and cause freeze-up/water leakage.

HOW TO CLEAN THE AIR FILTER

When the remote controller indicates **Time to clean filter**, clean the air filter.

- The prompt will display after running for a certain time.

NOTE

- You may change the time of indication **Time to clean filter**.
If the unit is used in a space where the air is more contaminated, ask your local dealer for solution.

Contamination	Time until indication is displayed
Normal	2500 hours (equivalent to one year)
More contaminated	1250 hours (equivalent to a half year)

- If it becomes difficult to remove contamination from the air filter, replace the air filter.
(Air filter for replacement is an optional accessory.)

1. Open the suction grille.

Simultaneously press the two knobs, slowly pull down the suction grille.

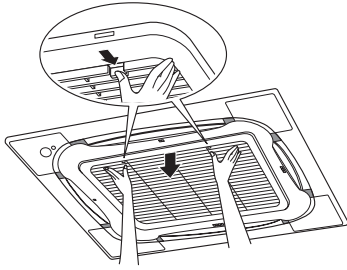

2. Take out the air filter.

Carry out the work taking the following steps:

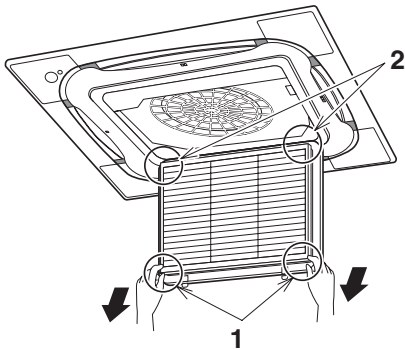

- 1 Pull the air filter end inclined downward and unhook the hooking hole of the air filter from the projection of the grille. (Both right and left)

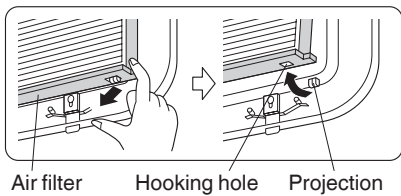

- 2 Lift the air filter and unhook the hooking hole of the air filter from the projection at the grille upper part. (Both left and right)

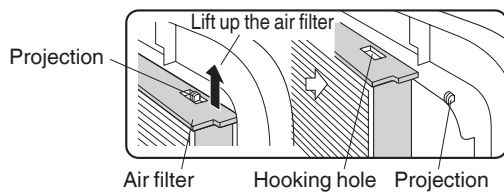

3. Clean the filter.

Clean the contamination with a vacuum cleaner or wash it with water.

If the air filter is extremely contaminated, wash it with neutral detergent using a soft brush.



After shaking off excess water, dry the air filter in the shade.

NOTE

- Do not wash the air filter with water of 122°F (50°C) or higher. It may cause decolorization and deformation.
- Do not heat the filter with a fire. It may cause burning.

4. Attach the air filter.

- Attach the air filter in the reverse order mentioned in the clause 2.

5. Close the suction grille.

Slowly lift the suction grille and securely fasten it to the main body of the decoration panel, while pressing the two knobs.

NOTE

- The straps may be caught when the suction grille is closed. Before closing the suction grille, ensure that the straps are not loose from the side of the suction grille.

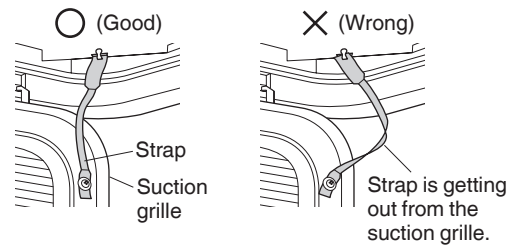

6. Turn off the indication Time to clean filter displayed on the remote controller after turning on the power.

- The indication can be turned off whether in operation or stopped. Refer to the operation manual attached to the remote controller.

HOW TO CLEAN THE SUCTION GRILLE

1. Open the suction grille.

Simultaneously press the two knobs and carefully pull down the suction grille.

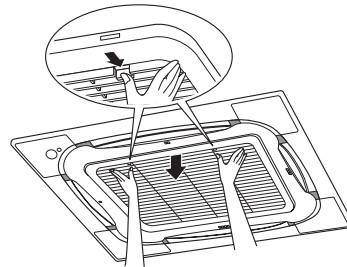

2. Remove the straps of the suction grille.

Remove the two straps holding the main part of the panel.

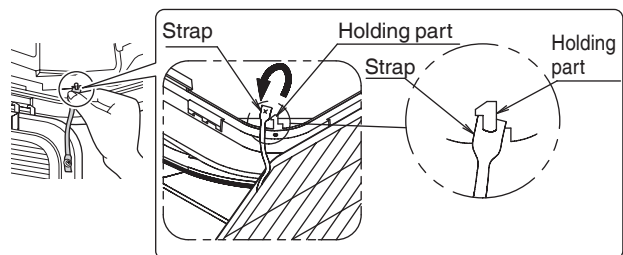

3. Remove the suction grille.

Open the suction grille 45° and lift it.
Then, unhook it from the three hooks.

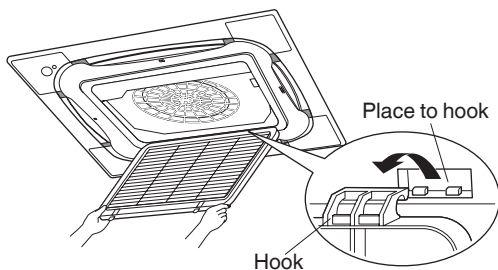

4. Take out the air filter.

Refer to clause 2 for **HOW TO CLEAN THE AIR FILTER.**
(Page 2)

5. Clean the suction grille.

Wash the suction grille with neutral detergent using a soft brush and then shake off water.

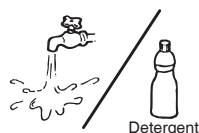

When the suction grille is extremely contaminated:

- Spray the detergent for a ventilating fans and ranges directly to the suction grille, and keep it under that condition for about 10 minutes.

After that, carefully wash the suction grille with water.

NOTE

- Do not wash the suction grille with water of 122°F (50°C) or higher.

It may cause discoloration and deformation.

- When drying the suction grille, do not heat it with fire. It may cause burning.

6. Attach the air filter.

Refer to clause 4 for **HOW TO CLEAN THE AIR FILTER.**
(Page 2)

7. Attach the suction grille.

Attach the suction grille in the reverse order mentioned in the clause 3.

8. Attach the straps of the suction grille.

Attach the straps in the reverse order mentioned in the clause 2.

9. Close the suction grille.

Refer to clause 5 for **HOW TO CLEAN THE AIR FILTER.**
(Page 2)

HOW TO CLEAN AIR OUTLET, SUCTION GRILLE, THE EXTERIOR AND REMOTE CONTROLLER

- Wipe them with a dry soft cloth.
- When the stain cannot be wiped off, dip the cloth in a neutral detergent diluted with water and twist the cloth.
After wiping off stain with this cloth, wipe them with a dry cloth.

NOTE

- Do not use substance such as gasoline, benzene, thinner, polishing powder and liquid insecticide sold in the market.
It may cause discoloration and deformation.
- Do not wash them with water of 122°F (50°C) or higher.
It may cause discoloration and deformation.
- Be careful not to damage the sensor surface.
The sensors, if damaged, may not provide correct sensing performance.